



R - RF

**Regulators for gas
with filter and safety diaphragm**

R - RF

Regulators for gas with filter and safety diaphragm

Contents

Description	2
Features	2
Functioning and application	3
Technical specifications	4
Gas flow chart (pressure drop)	6
Selection.....	9
Ordering information	10
Special versions and optionals	10
Design, installation and servicing	10
Standards and approvals	11

Description

The R type is a regulator for gas pipelines according to EN 88. It can be equipped with an integrated filter (type RF) according to DIN3386. This device is suitable for supplying clean gas at stable pressure to all the devices downstream.

Features

The regulators are made of aluminum alloy die-cast.

They are equipped with adjustable spring, so that outlet pressure can be precisely adjusted on site.

Regulators can also be equipped with a filter element with a very high holding capacity of dust and impurities (filtration grade <math>< 50\mu\text{m}</math>). Filter structure consists in a steel support frame covered with a double-layer high-performance nonwoven made of polyolefin fibers. Thanks to that, moving parts of regulator and other devices downstream are fully protected.

Regulators are equipped with working and safety diaphragms, hence it is not necessary to connect outside the vent line.

The closing plate is balanced with a specific compensating diaphragm, resulting in a very stable outlet pressure.

The impulse line is integrated inside the regulator. Special versions with external impulse line are available on request.

Pipe connections meet group 2.

R - RF regulators have been designed to generate low pressure drop with high flow.

The governors have the ability to lock up when there is no flow.

Suitable for use with air and non-aggressive gases included in the 1, 2 and 3 families (EN 437). Special versions for aggressive gases (Biogas, COG).

Provided with pressure test points on two sides in the inlet (after the filter cartridge) and outlet chamber to connect manometers, pressure switches or other gas equipments.

All components are designed to withstand any mechanical, chemical and thermal condition occurring during typical service. Effective impregnation and surface treatments have been used to improve mechanical sturdiness, sealing and resistance to corrosion of components.

Regulators are 100% tested and fully warranted.

Functioning and application

A regulator is a device able to maintain a stable pressure at the outlet, despite of changes of inlet pressure and/or gas flow rate. The outlet pressure pushes on the working diaphragm, acting against the spring. The disc moves until force of spring and outlet pressure are equal. If the flow decreases, e.g. because a downstream valve has been closed, a small increase in outlet pressure occurs, so the disc moves to reach a new position, balanced between outlet pressure and spring. If higher outlet pressure is needed, the regulating screw must be tightened, increasing the force of spring. Variation of inlet pressure does not affect outlet pressure because the closing plate is compensated with the compensating diaphragm. If the flow stops, the outlet pressure increases just slightly, as the disc has a gasket and closes perfectly the passage.

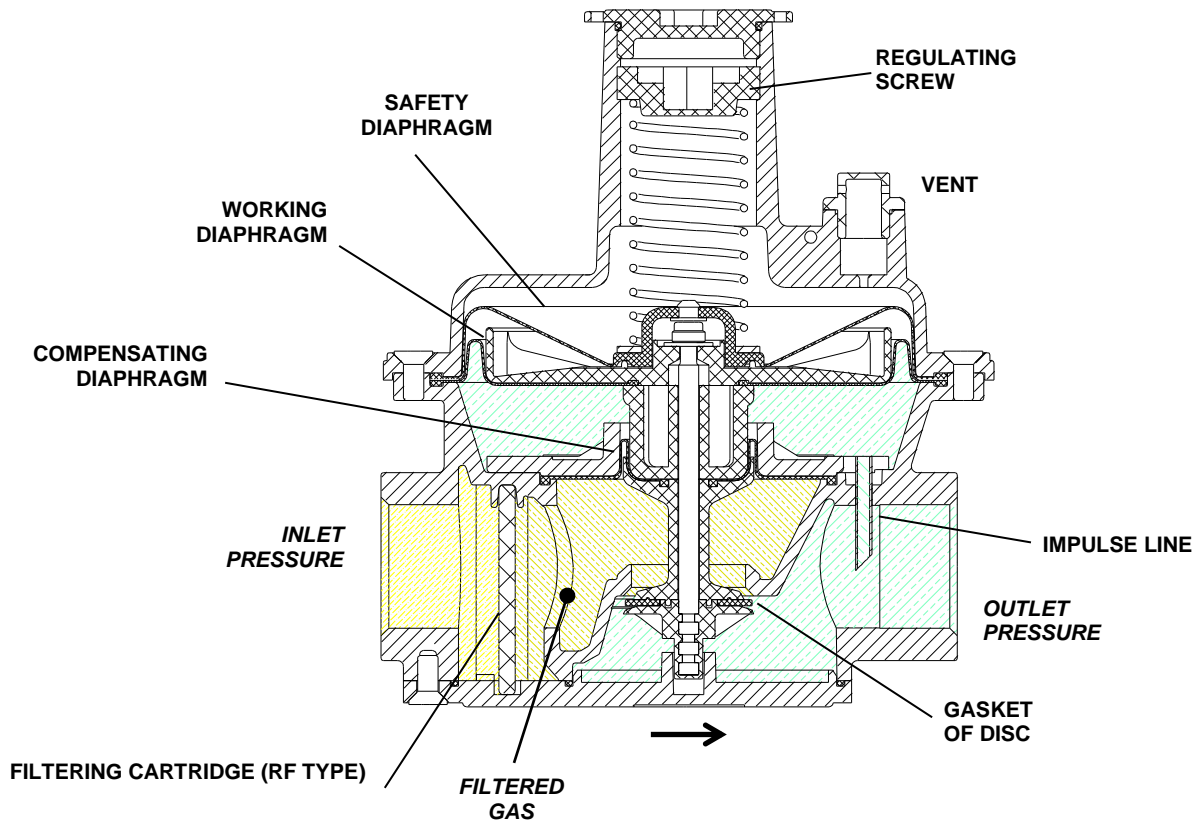

Fig.1

This device is normally installed in gas trains, industrial applications and gas firing systems.

Figure 2 shows an example of installation with other Elektrogas devices.

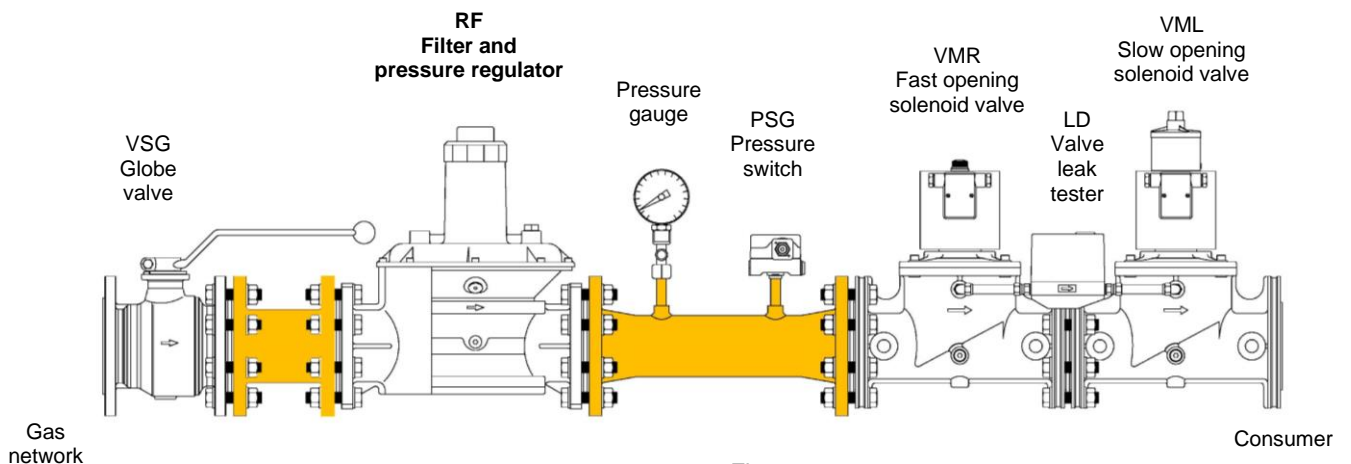

Fig.2

Technical specifications

Tab. 1

Connections	Gas threaded F/F ISO 7-1 from Rp1/2 to Rp2 or ANSI-ASME B1.20 from 3/4"NPT to 2"NPT Flanged PN16 – ISO 7005 DN40 – DN100
Ambient temperature	-15°C ... +60°C
Inlet-Outlet pressure	R or RF models Inlet pressure: Max 500mbar (50 KPa) or Pout + 5mbar Testing pressure: max 750 mbar – outlet 500mbar Regulating class: Class A - EN88 (± 1 mbar or $\pm 15\%$ of set value) For Outlet pressure see Tab. 2
Lock up pressure	SG30 for lock-up (+7.5mbar or +30% of set value)
Flow capacity	see charts
Filtration grade	RF (filtering cartridge): $\leq 50 \mu\text{m}$
Installation	1/2"-2": horizontal (with settable spring upward) or vertical pipeline 2"1/2-3"-4": only horizontal pipeline (with settable spring upward)
Gas type	Air, natural gas, town gas, LPG (gaseous) of families 1,2,3 (EN437)
Materials in contact with gas	Aluminum alloy, Brass, Stainless steel, Plated steel, Polyamide, Anaerobic adhesive Nitrile rubber (NBR), Fluoro elastomer (FPM), Polytetrafluoroethylene (PTFE)
Specifications of J version for biogas or COG	Free of brass Seals made of Fluoroelastomer (FPM) instead of NBR Ambient temperature -10/+60° Max gas inlet pressure 200mbar (Max outlet pressure 160 mbar)

OUTLET PRESSURE RANGE (mbar):

Tab. 2

	<i>Model</i>	R..1	R..2 R..3	R..35	R..4 R..6	R..7 R..8 R..9
Spring color						
Green	...A..	5-13	9-16	5-13	9-18	5-13
Red	...B..	7-20	13-26	7-20	15-30	7-20
Neutral	...C..	10-30	20-40	10-30	25-60	10-30
Yellow	...D..	25-70	30-60	25-70	50-120	25-70
Violet	...E..	60-150	50-100	60-150	100-250	60-150
Orange	...F..	-	80-160	140-300	-	140-300
Blue	...G..	-	125-250	-	-	-

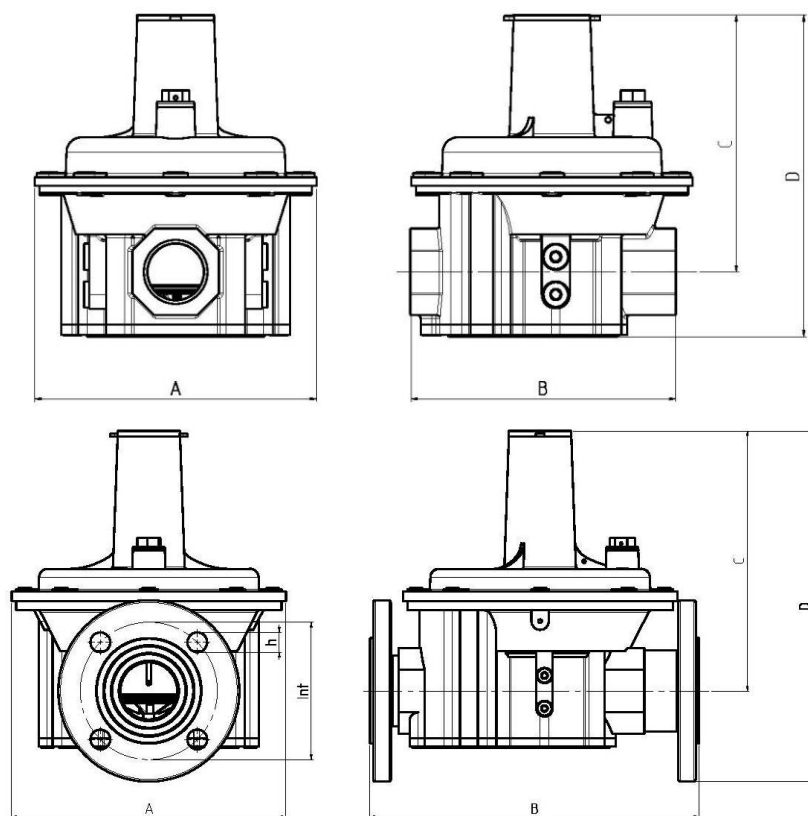

Fig.3

Tab. 3

Model	Connection	Overall dimensions [mm]						Weight (Kg)
		A	B	C	D	Int	h	
R..1	½"	96	105	111	142	-	-	0,70
R..2	¾"	150	141.5	137	171	-	-	1,45
R..3	1"	150	141.5	137	171	-	-	1,44
R..35	1¼"	192	194	214	255	-	-	3,10
R..4	1½"	250	236	267	316	-	-	5,00
R..6	2"	250	236	267	316	-	-	5,00
R..4F ¹	DN40 fl.	250	311	214	285	110	4x18	7,30
R..6F ¹	DN50 fl.	250	352	267	350	125	4x18	7,50
R..7	DN65 fl.	325	430	335	430	145	4x18	12,5
R..8	DN80 fl.	325	430	335	430	160	8x18	12,5
R..9	DN100 fl.	325	430	335	430	180	8x18	12,5

(¹) with flanged connection kit mounted

Flow chart with disc blocked in open position

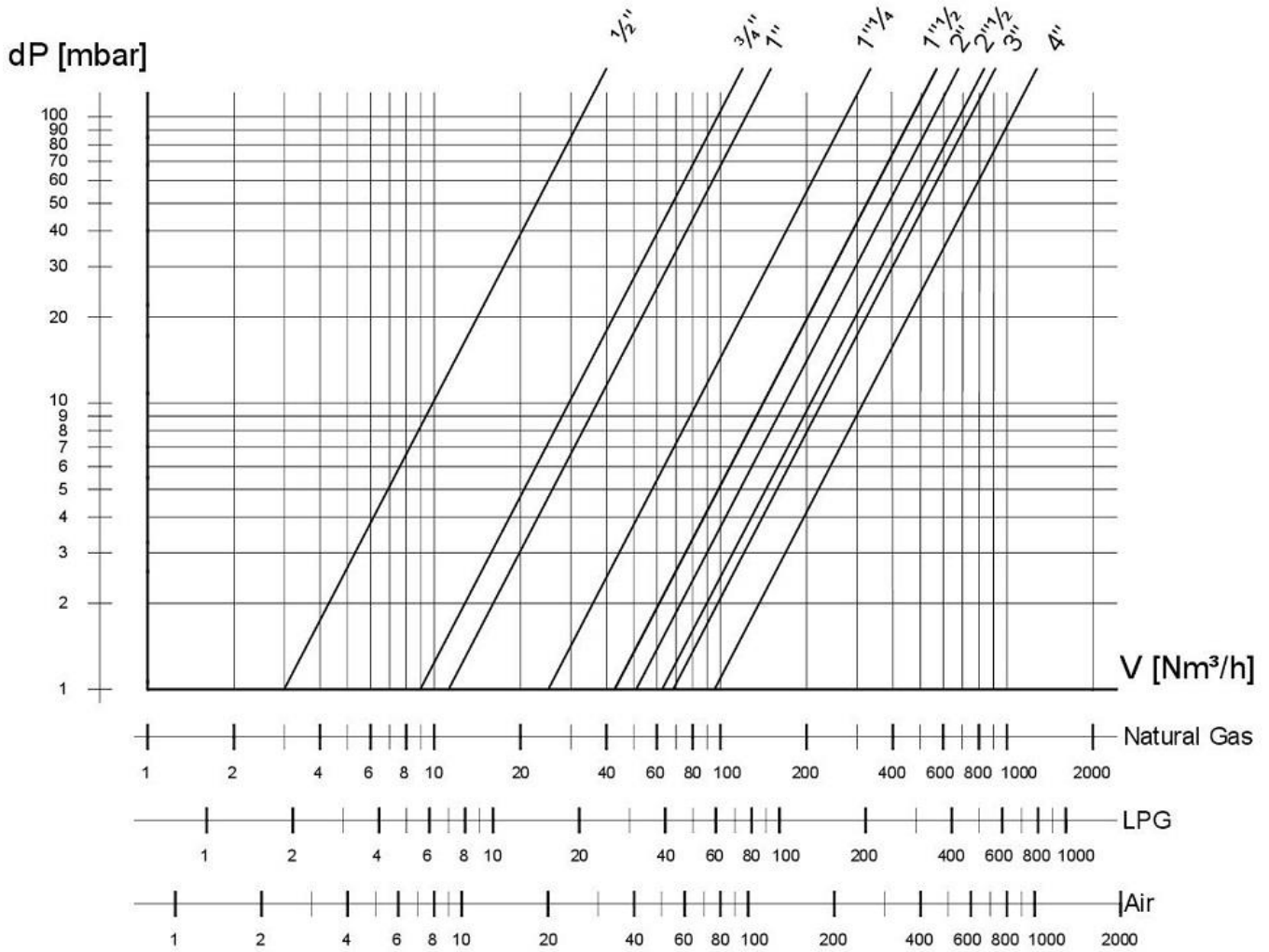

Fig. 4

Conversion of flow from air to other gases

Tab. 4

$$V_{GAS} = k \cdot V_{AIR}$$

Gas type	Specific gravity ρ (typical value) [Kg/m³]	$k = \sqrt{\frac{1.25}{\rho_{GAS}}}$
Natural gas	0,80	1,25
LPG	2,08	0,77
Air	1,25	1,00

Maximum Flow chart in operation

1/2"

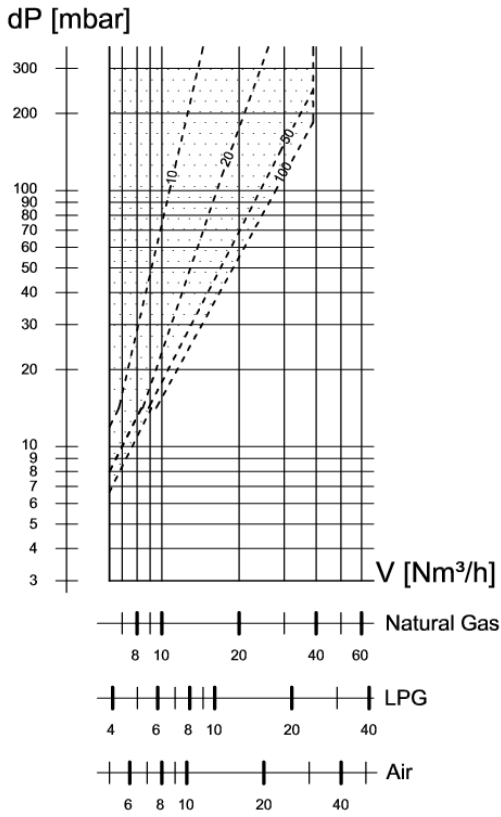

3/4"

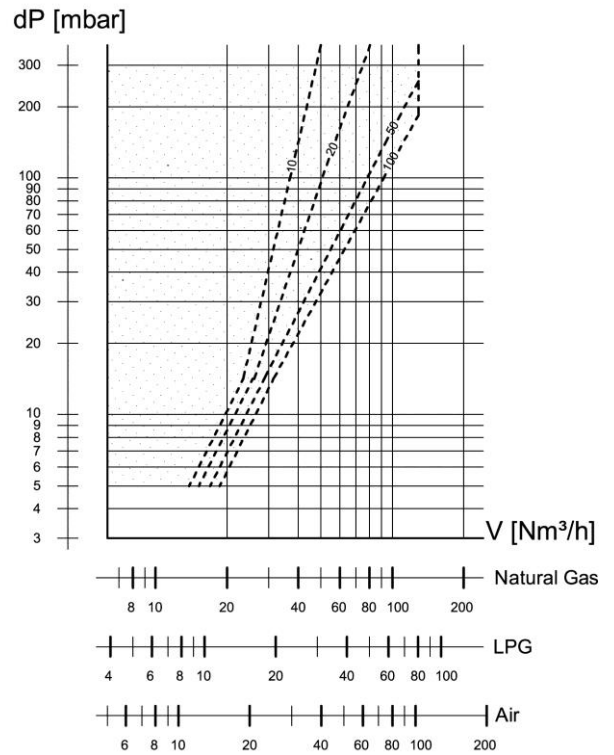

1"

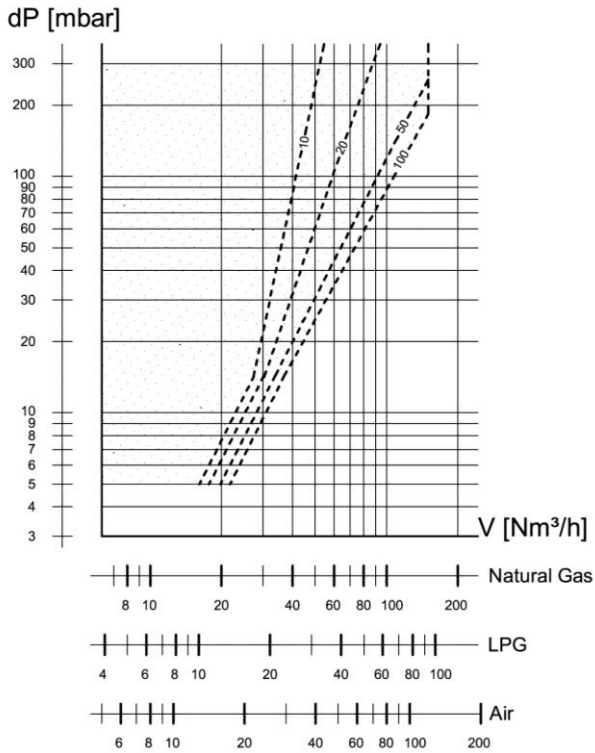

1 1/4"

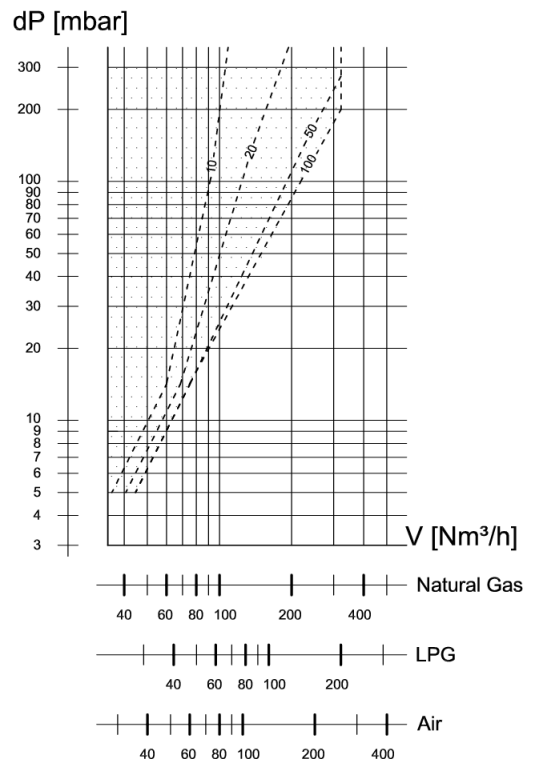

1”½-2”

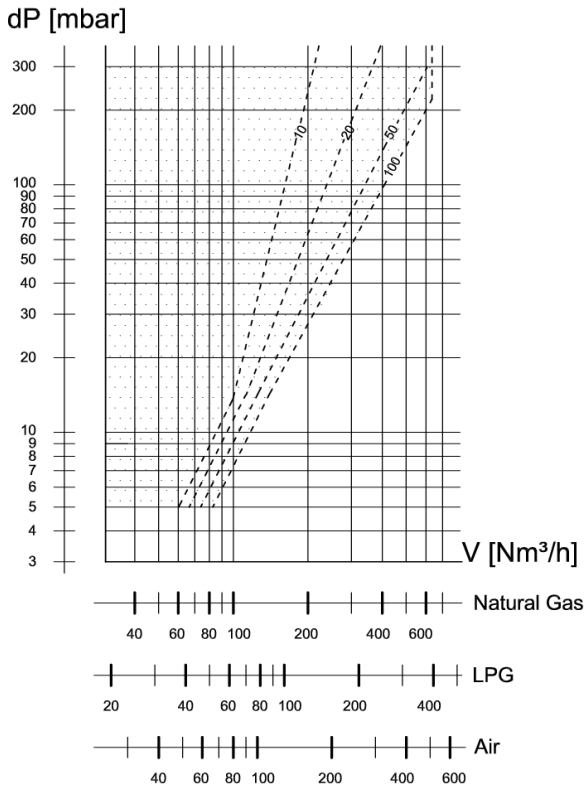

2”½-3”

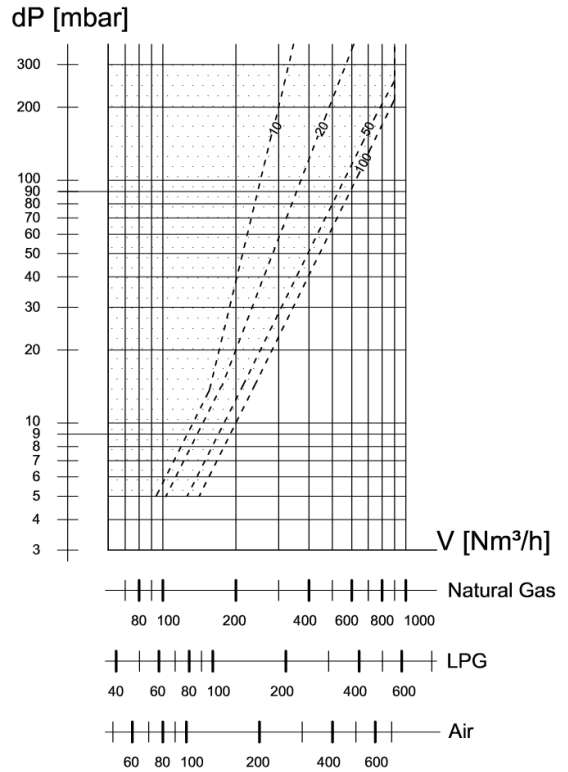

4”

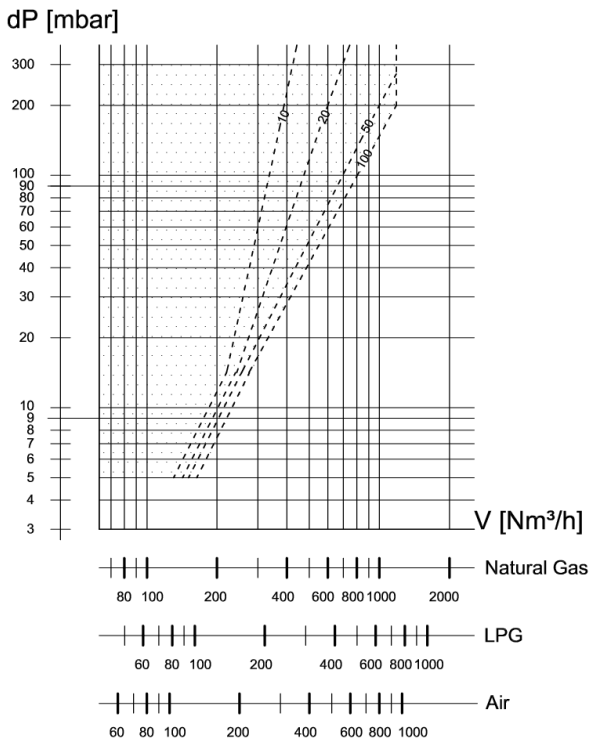

Fig. 5

$V_{min} < 10\% V_{max}$

Selection

To select a regulator consider:

- gaseous media (natural gas, LPG,...)
- inlet and outlet pressure
- maximum flow

The regulator will work properly if inlet pressure is higher than outlet pressure and pressure drop with an adequate margin. The pressure drop can be read from maximum flow chart. If your outlet pressure curve is not present, consider the lower curve.

To avoid noise and excessive turbulence, the gas speed at outlet pipe should be not higher than 30 m/s, otherwise the next bigger size of outlet pipe should be chosen.

Example:

Select a regulator :

- for Natural Gas (CH₄)
- inlet pressure 170mbar
- outlet pressure 40 mbar
- max flow 60 Nm³/h

Considering inlet and outlet pressure, the available pressure drop is:
170 – 40 = 130mbar.

In the Flow chart of disc in open position (fig. 4) with available pressure drop we see the maximum theoretically flow of a regulator, so we can make a first selection: for sure we need a regulator 3/4" or higher.

Now we consider the maximum flow of a regulator 3/4" in operation (Fig.5 - 3/4").

As the graph with outlet pressure 40mbar is not present, we consider the lower one, 20mbar curve.

Considering this curve of 3/4", we read a requested pressure drop of approximately 150mbar. As the available pressure drop is lower, we need a bigger regulator.

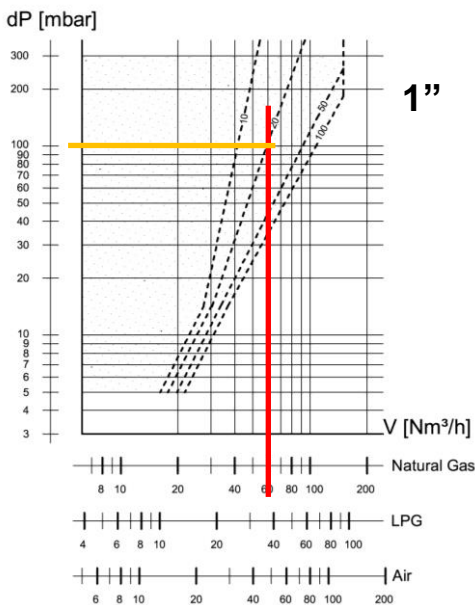
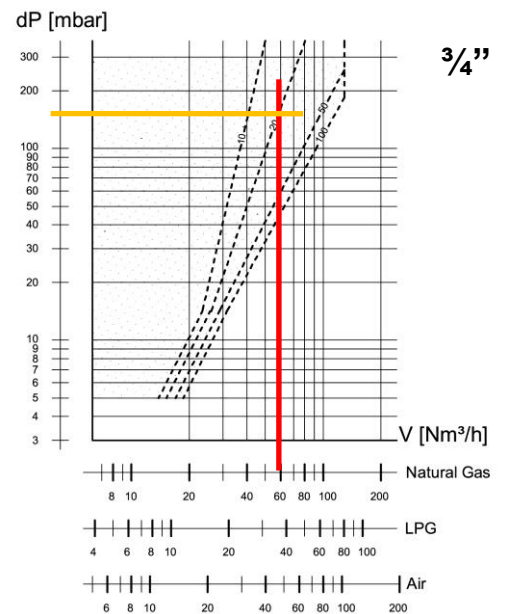
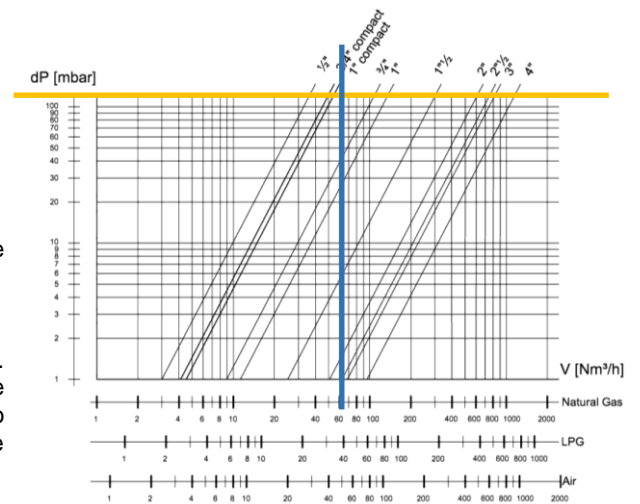

Making similar consideration with maximum flow chart of a regulator 1", we read a pressure drop of 100mbar. We advise to consider a working margin of at least 20%:
Available pressure drop must be higher than:
 $100 \times 120\% = 120\text{mbar}$

With 1", maximum pressure drop is higher so the regulator will work properly (tolerances prescribed by EN 88-class A).

We calculate the gas speed at outlet to avoid noise:
Pipe 1", internal diameter 28mm, speed 25 m/s
The regulator will work well.

Ordering information

		RF	3	B
Regulator type				
R = regulator				
RF = regulator with filter				
Connections size				
1	Rp1/2			
2	Rp3/4			
2N	3/4"NPT			
3	Rp1			
3N	1"NPT			
35	Rp1¼			
4	Rp1½			
4N	1½"NPT			
6	Rp2			
6N	2"NPT			
4F	DN40			
6F	DN50			
7	DN 65			
8	DN80			
9	DN100			
Outlet pressure (mbar)				
	R..1	R..2-3	R..4-6 4F-6F	R35 7-8-9
A	5-13	9-16	9-18	5-13
B	7-20	13-26	15-30	7-20
C	10-30	20-40	25-60	10-30
D	25-70	30-60	50-120	25-70
E	60-150	50-100	100-250	60-150
F		80-160		140-300
G		125-250		
Special version				
- standard				
.J version for bio and coke gas (only with metallic filter – R type)				

Example: **RF3B**: regulator with connection Rp1, filtering cartridge and outlet pressure 13-26mbar

Special versions

Regulators can be supplied in special versions for aggressive gases such as Biogas and COG (version J), see Tab. 2 for technical features. It is recommended to check compatibility of gas contents and regulator materials before installation.

Regulators can be supplied in special versions for higher inlet pressure (1 bar or 2 bar), contact our sales office for further details.

Design, installation and service

To assure a proper and safe operation, as well as a long service life of the regulator, consider the following recommendations:

- ✓ Ensure that all the features of your system comply with the specifications of the regulator (gas type, operating pressure, flow rate, ambient temperature, etc.).

- ✓ Governor till 2" may be mounted with spring in horizontal or vertical position (dome upward). In the event of vertical pipe, the flow direction should be from bottom to top. Governor larger than 2" can be mounted only with spring in vertical position (horizontal pipe) and dome upward.
- ✓ Avoid to install the regulator in the open air, ensure that installing area is dry, especially the vent cap has to be free from dirty and water.
- ✓ Make sure all works are performed by qualified technicians only and in compliance with local and national codes.
- ✓ After removing the end caps, make sure no foreign body will enter into the governor during handling or installation (e.g. swarf or excessive sealing agent). Manage the device with proper tools.
- ✓ Perform leak and functional tests after mounting (see Tab. 1 for max. testing pressure).
- ✓ To adjust the spring, remove the protective cap and turn the adjusting screw with an Allen key. Turning clockwise the outlet pressure increases, counterclockwise it decreases. After adjustment, remount protective cap.
- ✓ To change the spring: remove the protective cap and the adjusting screw, remove the original spring and put the new one, reassemble in reverse order, set the new spring. Stick the label with new outlet pressure.
- ✓ The regulator needs no maintenance, only the filter can be cleaned or replaced. We recommend to perform an external and functional check at least once a year. Twice in case of biogas or COG.
- ✓ To clean or replace the filter:
 - Shut off the gas.
 - decompress the spring, turning counter-clockwise the adjusting screw to the minimum position.
 - open the inferior cover using a proper key.
 - extract the filtering cartridge or the metallic filter. Pay attention to eventual dirt before the filter, it has to be remove before removing the cartridge.
 - clean it with compressed air or replace with a new identical one. Due to the features of the material of filtering cartridge, compressed air is not able to clean perfectly it as dirt is blocked inside fibbers, only a new cartridge can give optimal performance.
 - remount every parts in inverse sequence. Pay attention to insert the rod of closing element in the hole of the cover during reassembly.
 - Perform leak test.
 - set the outlet pressure to the right value and perform a functional test
- ✓ Due to rubber seals aging, to ensure safe operation, we recommend the replacement after 10 years from the date of manufacture printed on the product.
- ✓ This device must be installed in compliance with the rules in force.

For more details see the [Installation and Service Instructions](#).



Standards and approvals

The regulators are designed and manufactured according to European norm EN 88-1.

Quality Management System is certified according to UNI EN ISO 9001.



Copyright © 2020
All rights reserved

The information in this document contains general descriptions of technical options available and based on current specifications.

The company reserves the right to make changes in specifications and models as design improvements are introduced, without prior notice.

Elektrogas is a brand name of:

Elettromeccanica Delta S.p.A.
Via Trieste 132
31030 Arcade (TV) – ITALY

tel +39 0422 874068
www.delta-elektrogas.com
info@delta-elektrogas.com